

DATA SHEET

P/N	DESCRIPTION
CUBR120005	TERMINATION WR75 5W

ELECTRICAL DATA	NOTES
FREQUENCY RANGE	9.54 -15.00 GHz
V.S.W.R.	01:05
POWER	5W

MATERIAL DATA		
CONNECTOR PART	MATERIAL	PLATING
WAVE GUIDE WR75	COPPER	
FLANGE	BRASS	
2002/95/EC (RoHS)	COMPLIANT	

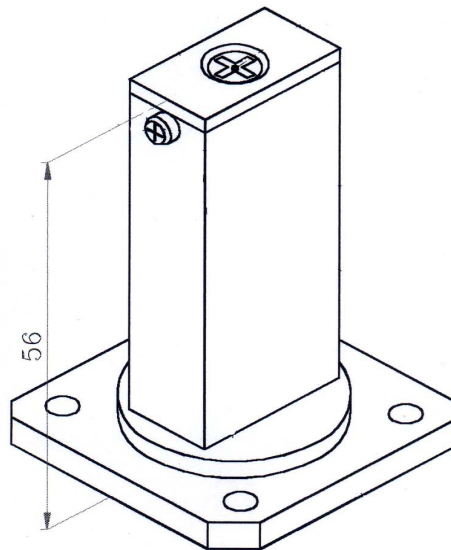

Dimensions mm